

dgc/ 624(02)CUR

RACCOLTA
DI
PROGETTI DI COSTRUZIONI

IN LEGNO ED IN METALLO

PER

Gorrieri Domenico

Ingegnere, Insegnante di statica grafica ed Assistente alla cattedra di ponti e costruzioni idrauliche
nella Regia Scuola d'applicazione per gli Ingegneri di Bologna

TAVOLE IN-FOLIO AD ILLUSTRAZIONE DEL TESTO

della Dispensa 4^a del Volume V

DELL'

APPENDICE ALL'ARTE DI FABBRICARE

iniziata dall'Ingegnere

GIOVANNI CURIONI

già Professore di costruzioni civili, stradali ed idrauliche nella Regia Scuola d'applicazione per gli Ingegneri di Torino



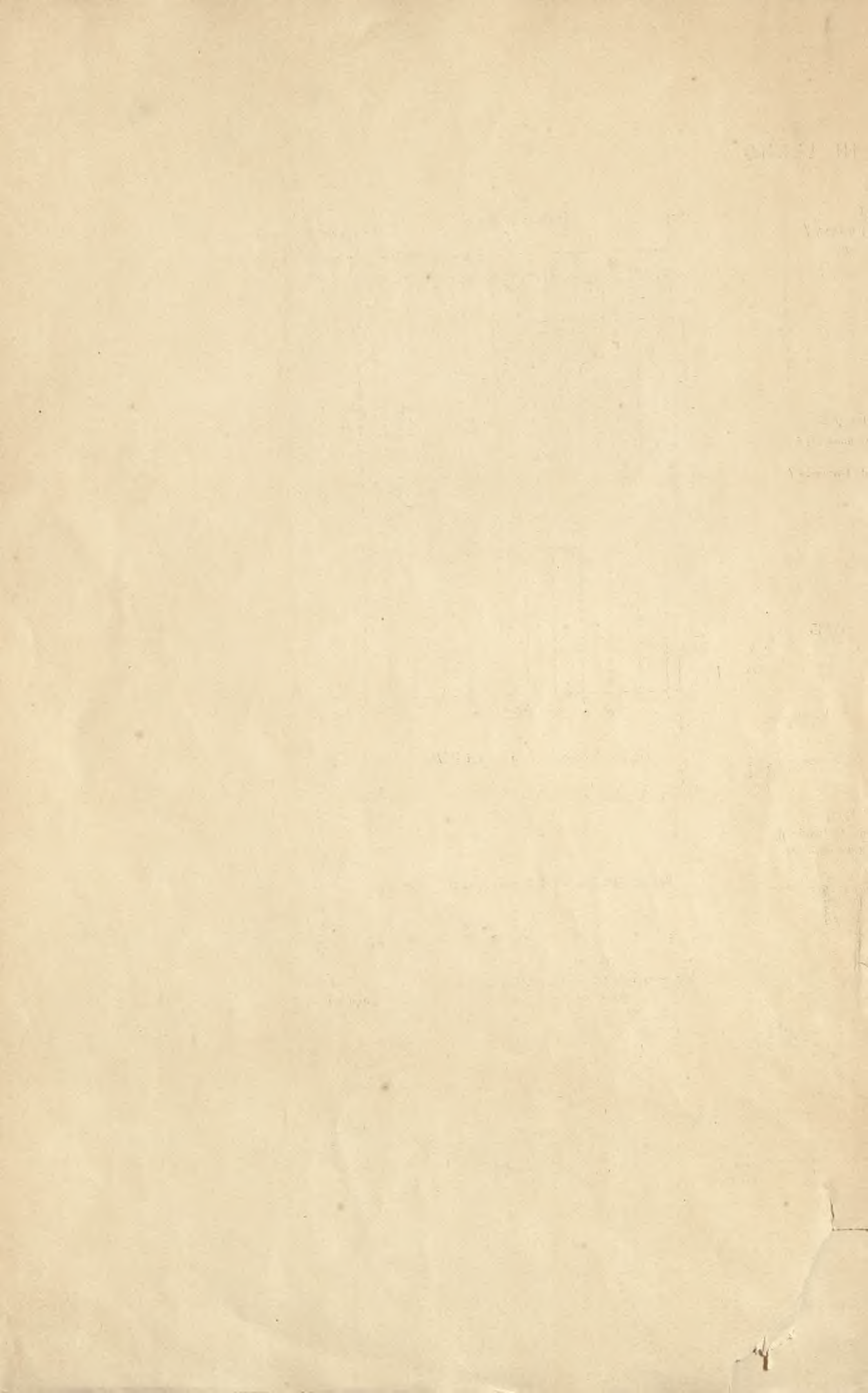
TORINO

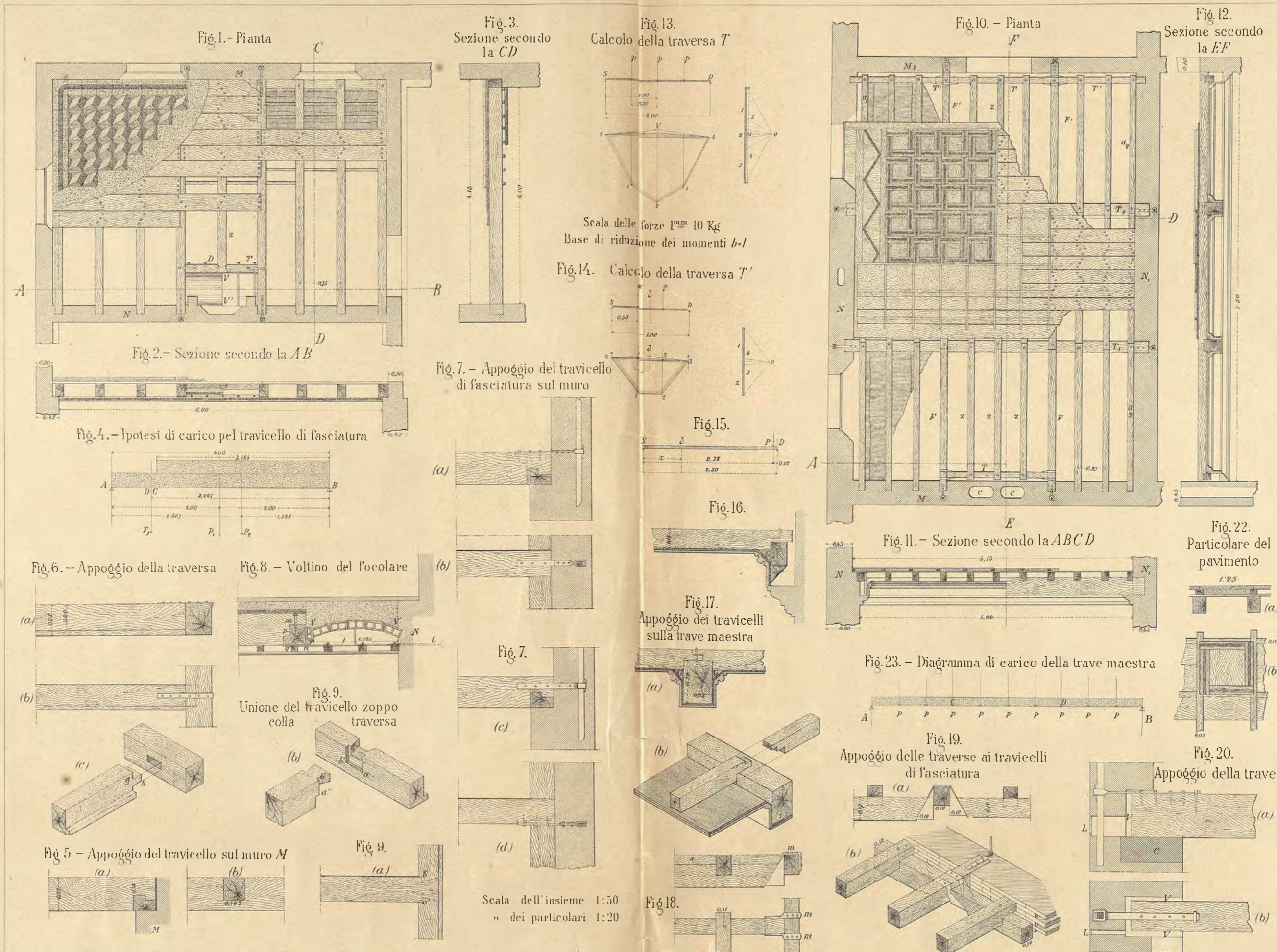
PRESSO **AUGUSTO FEDERICO NEGRO**, Editore
nella Galleria Nazionale

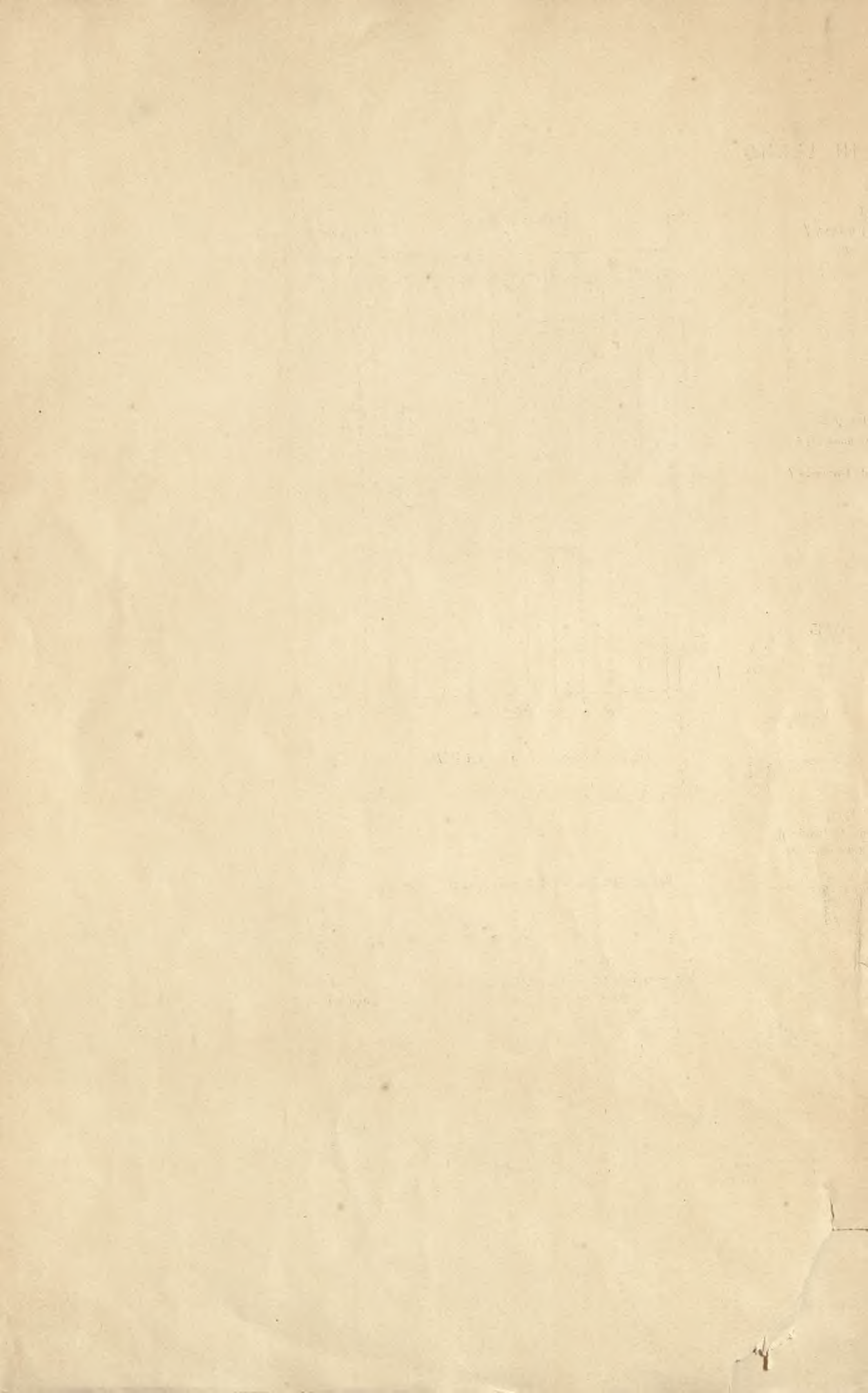
1893

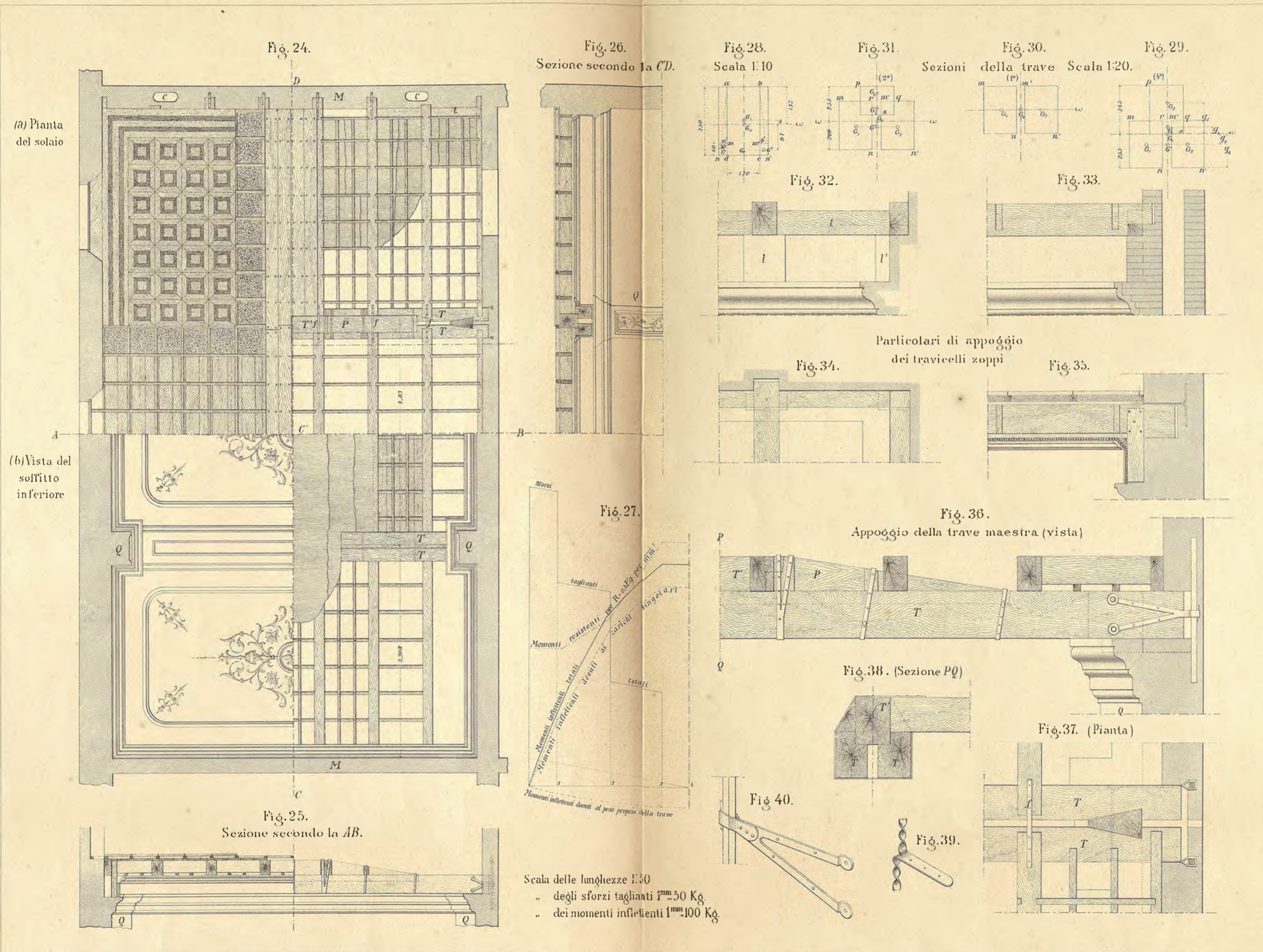












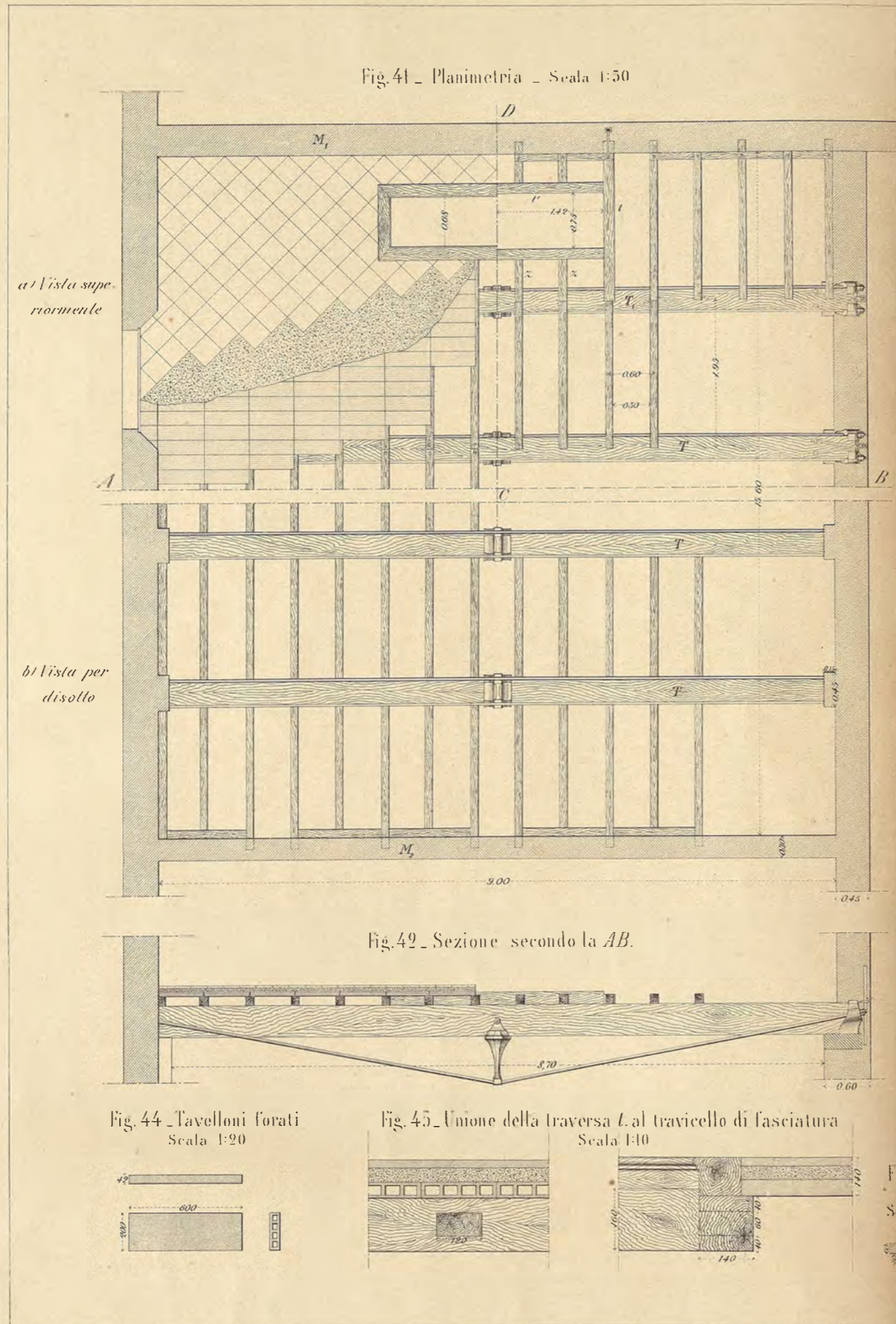


Fig. 43. Sezione secondo la CD.

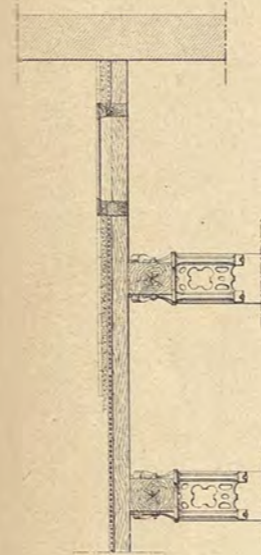


Fig. 47. Controfitto - Scala 1:20

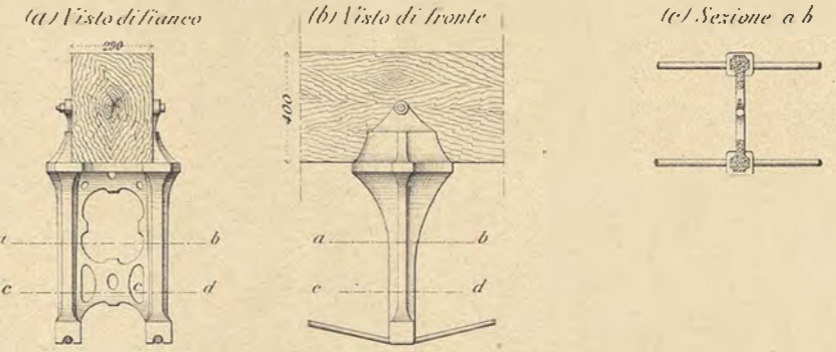


Fig. 48 - Sezione cd.

Scala 1:5



Fig. 49 - Sezione ab.

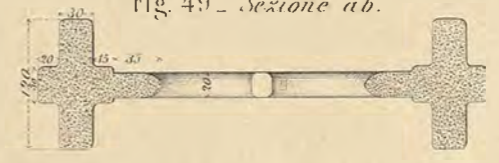


Fig. 50 - Appoggio della trave - Scala 1:20

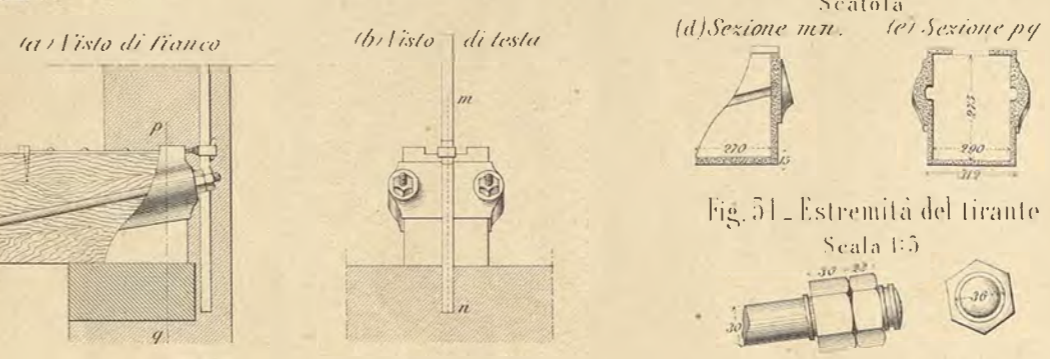


Fig. 51 - Estremità del tirante - Scala 1:5



Fig. 52 - Unione del travicello zoppo alla traversa - Scala 1:10

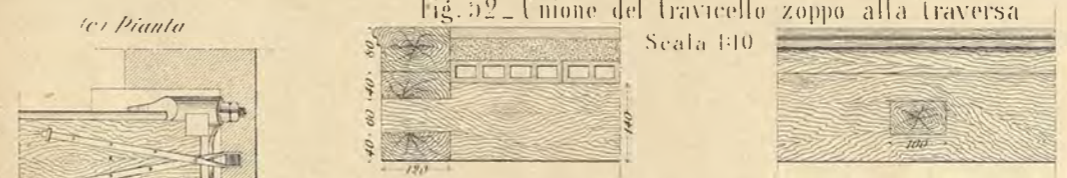


Fig. 53 - Diagramma delle forze esterne

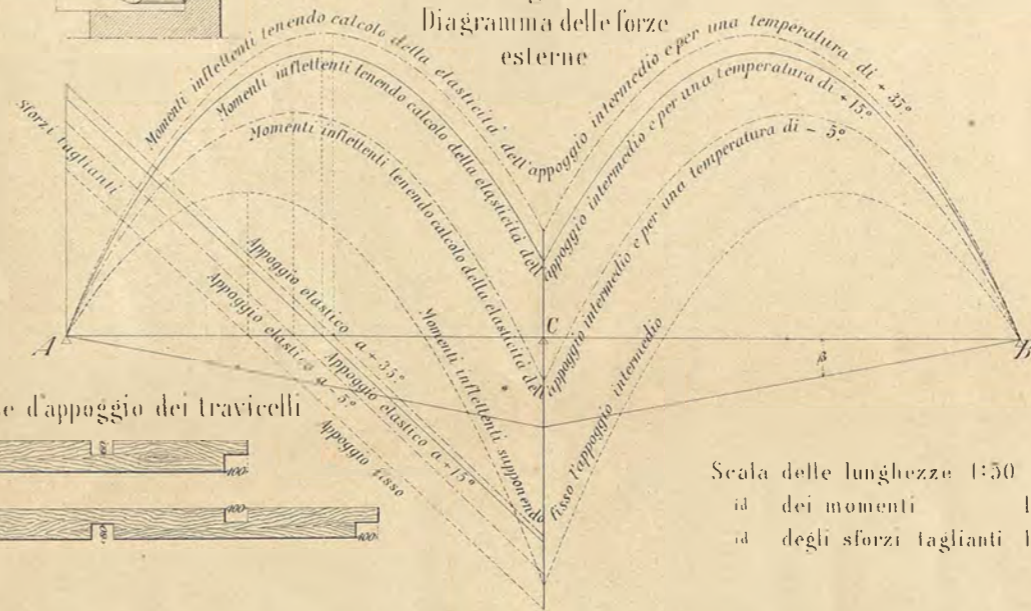


Fig. 46 - Traversi d'appoggio dei travicelli - Scala 1:25



Scala delle lunghezze 1:50
 m dei momenti 1^{mm} = 50 Kg.
 m degli sforzi taglianti 1^{mm} = 50 Kg.

Fig. 54 - Trave armata a due controfissi
(Scala di 1:50)

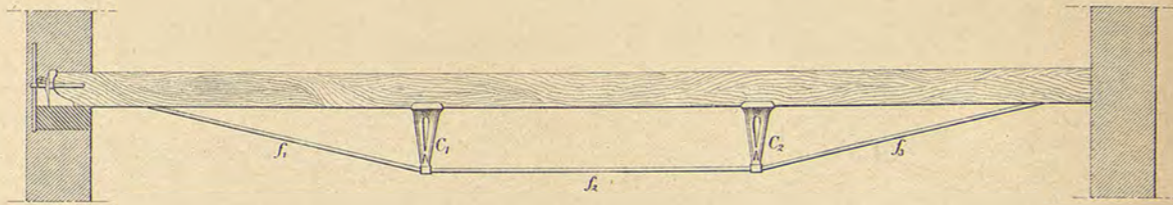


Fig. 55 - Diagramma dei momenti inflettenti
(Scala delle lunghezze 1:50) (Scala dei momenti 1%_m = 20 Kg_m)

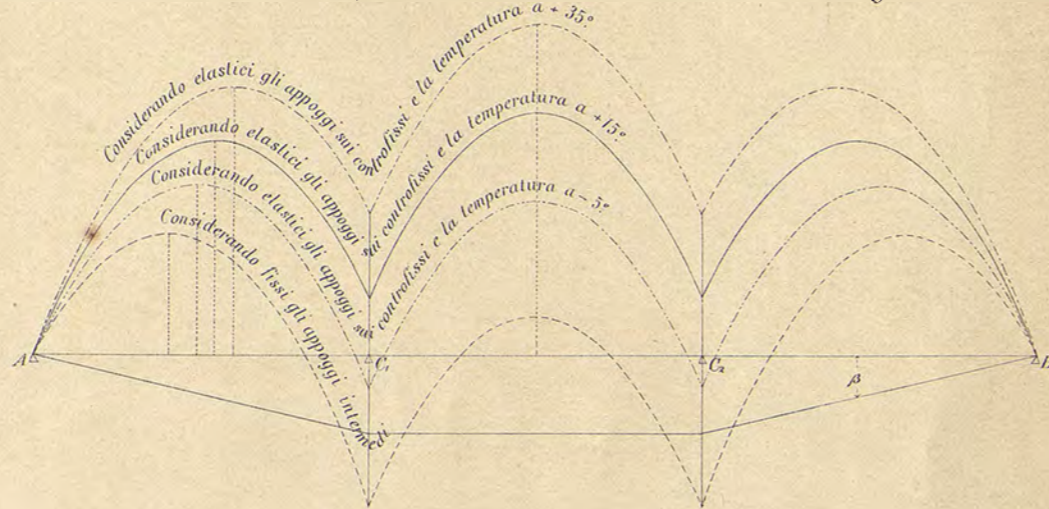


Fig. 56 - Diagramma degli sforzi massimi di compressione per %_q di Sezione
(Scala delle lunghezze 1:50) (Scala delle forze 1%_m = 10 Kg.)

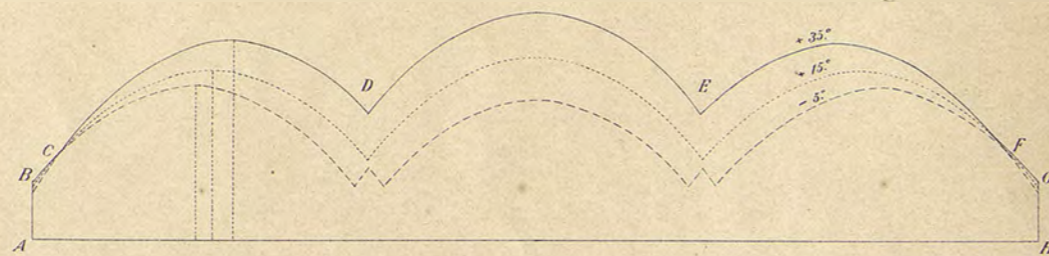


Fig. 57 - Controfissi (Scala di 1:20)

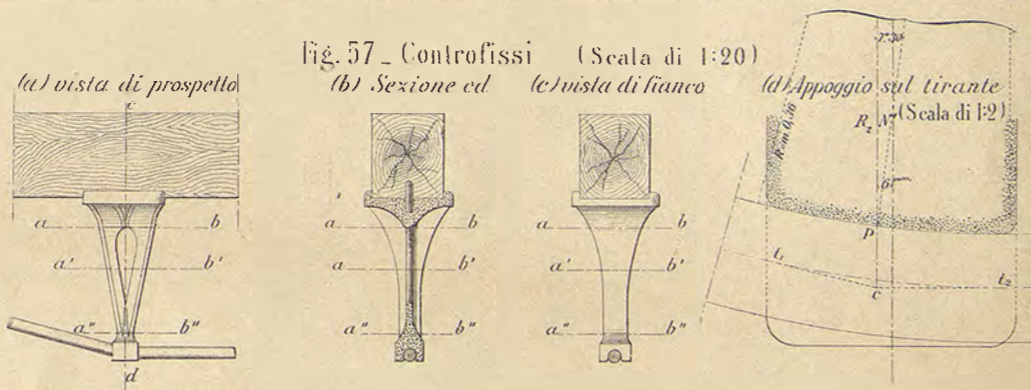
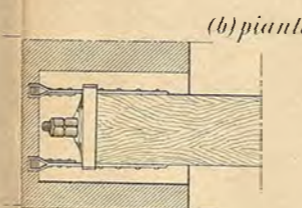
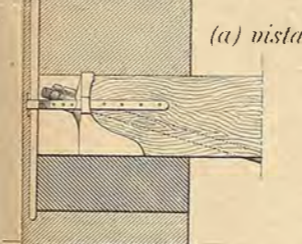


Fig. 60 - Sezione AB



Fig. 58 - Appoggio della trave (1:20)



Scatola in ghisa
Sezione ab

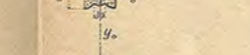


(e) Vite e dado del tirante
(Scala di 1:5)



Scala di 1:10

(e) Sezione a-b'



(f) Sezione a-b'



(g) Sezione ab

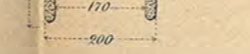


Fig. 66 - Sezione della trave all'incastro delle traverse

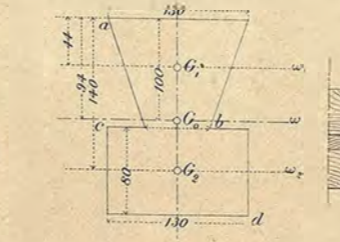


Fig. 59 - Pianta del solaio
(Scala di 1:50)

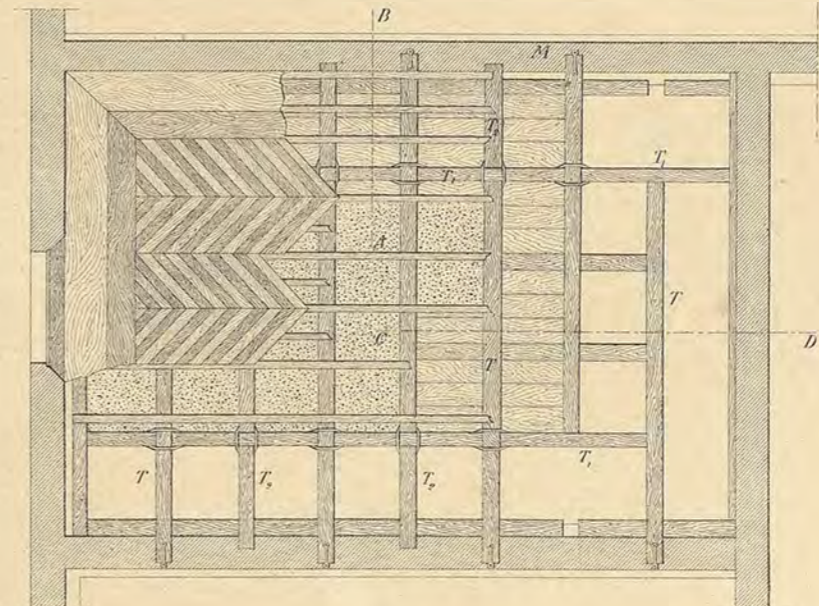


Fig. 63 - Soffitto

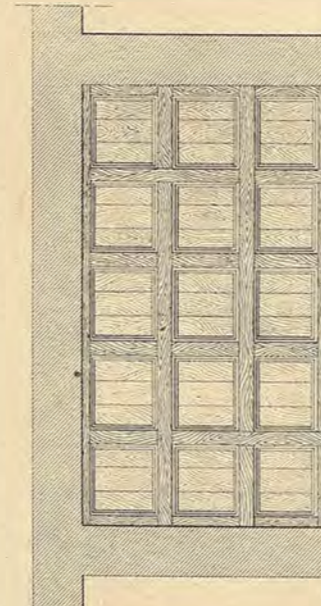


Fig. 61 - Sezione CD

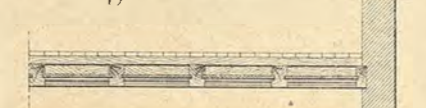


Fig. 62 - Attacco del soffitto (1:20)

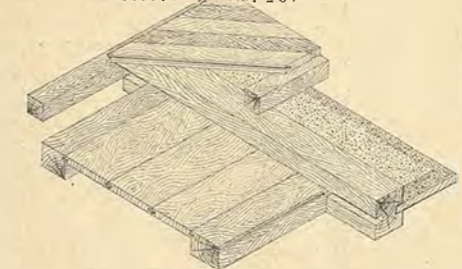


Fig. 64 - Appoggio della trave (1:20)

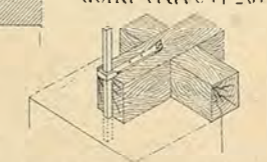


Fig. 65 - Cornici dei cassettoni (1:10)

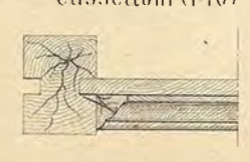


Fig. 67 - Incastro della trave alla traversa (1:10)



STUDI DI SOLAI IN FERRO

Raccolta di progetti di costruzioni in legno ed in metallo.

Tavola V.

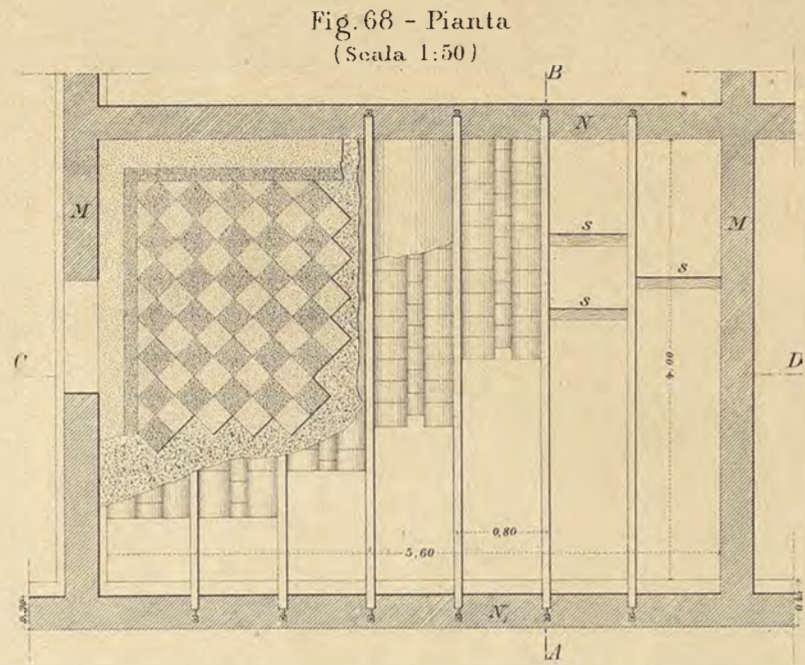


Fig. 69 - Sezione AB



Fig. 78 - Pianta del solaio del soffitto (Scala 1:50)

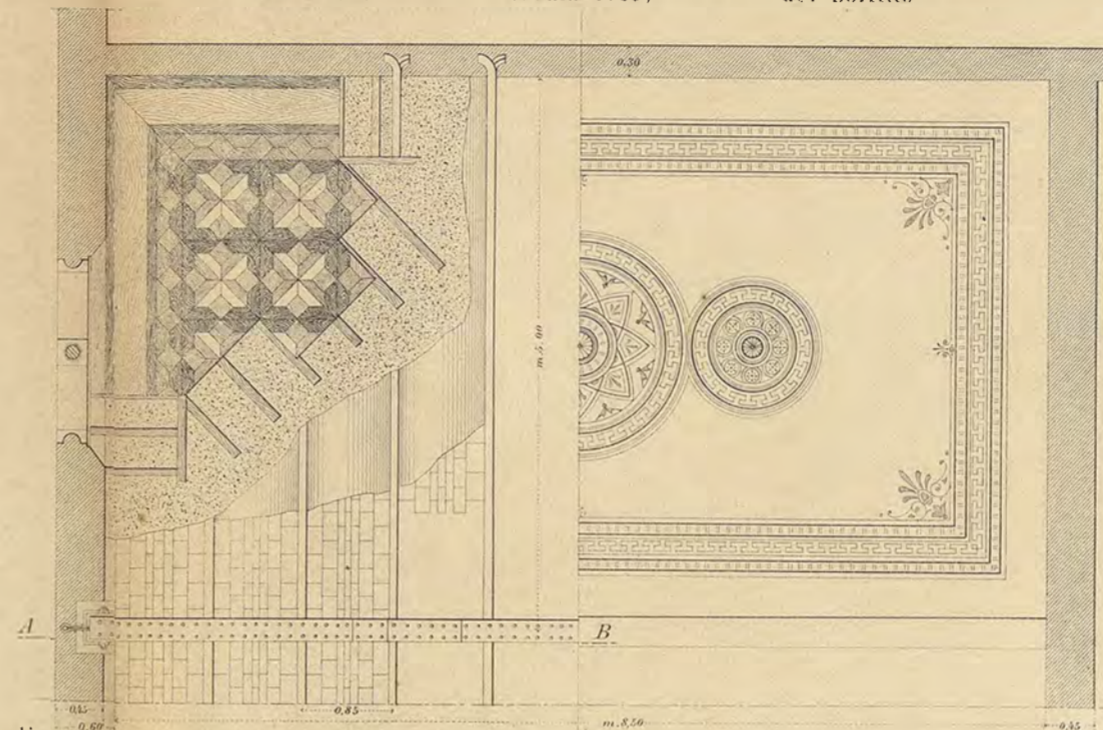


Fig. 85 - Appoggio dei travicelli (Scala 1:20)

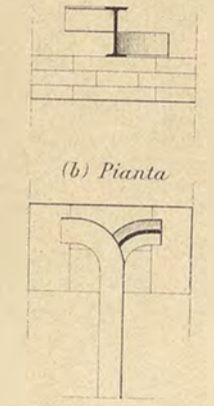


Fig. 70 - Sezione CD

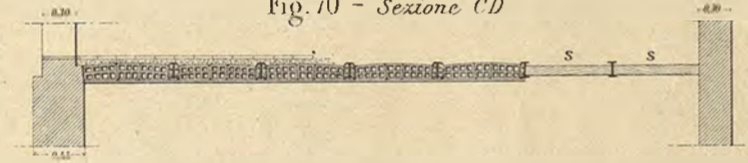


Fig. 73 - Volterrana intermedia (Scala 1:20)



Fig. 79 - Vista della trave Sezione AB

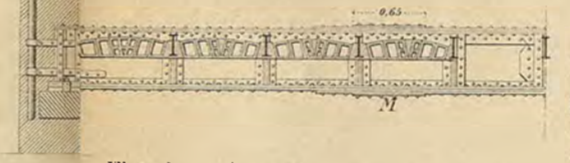


Fig. 81 - Attacco del travicello alla trave (Scala di 1:10)

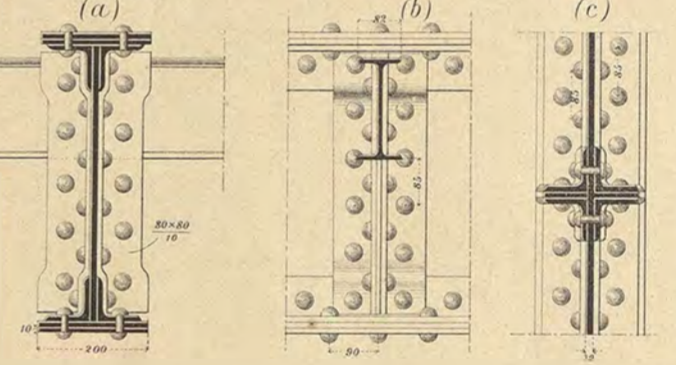


Fig. 72 - Vista prospettica del solaio

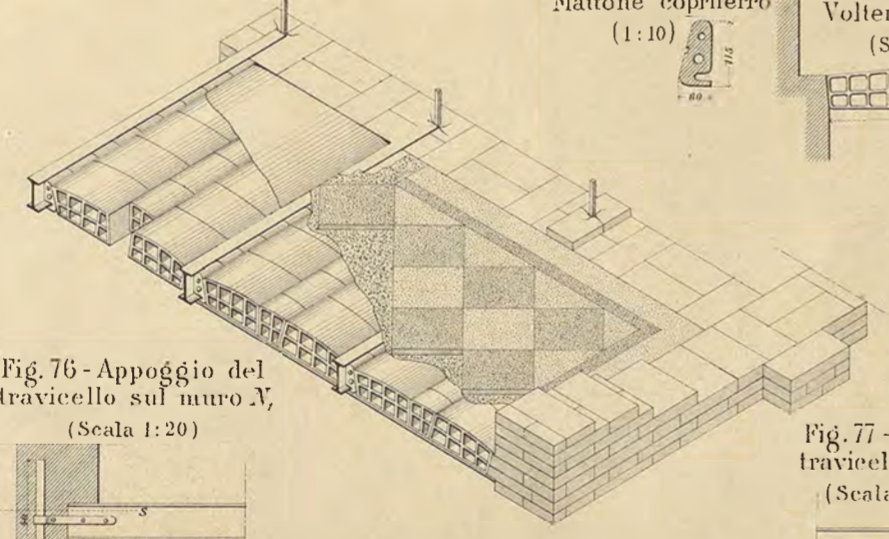


Fig. 71 - Mattoni copriferro (1:10)

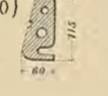


Fig. 74 - Volterrana estrema (Scala 1:20)

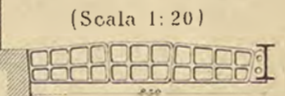


Fig. 80 - Appoggio della trave (a) Vista (b) Sezione PQ (Scala 1:5)

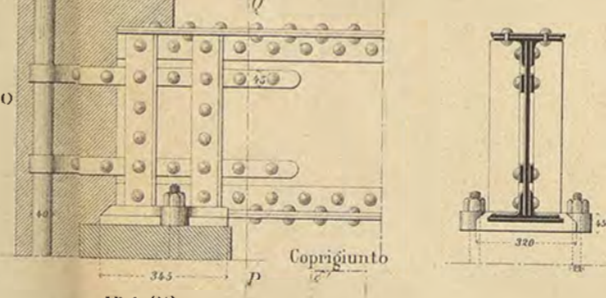


Fig. 75 - Sez. del travicello (Scala 1:5)



Fig. 76 - Appoggio del travicello sul muro N (Scala 1:20)

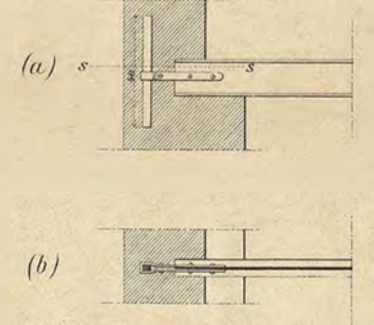


Fig. 77 - Appoggio del travicello sul muro N (Scala 1:20)



(Scala per la fig. 72)



Scala delle forze 1^{mm} = 200 Kg. - dei momenti 1^{mm} = 500 Kgm.

Fig. 83 - Fasciatura della trave maestra (a) Vista (b) Sezione (Scala di 1:10)

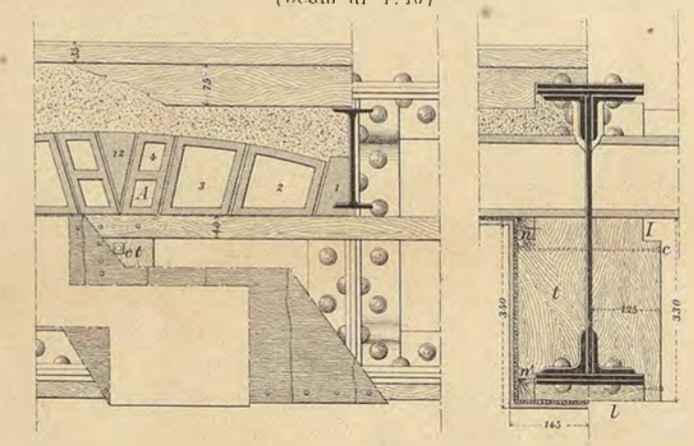


Fig. 86 - Pianta del 1° Piano

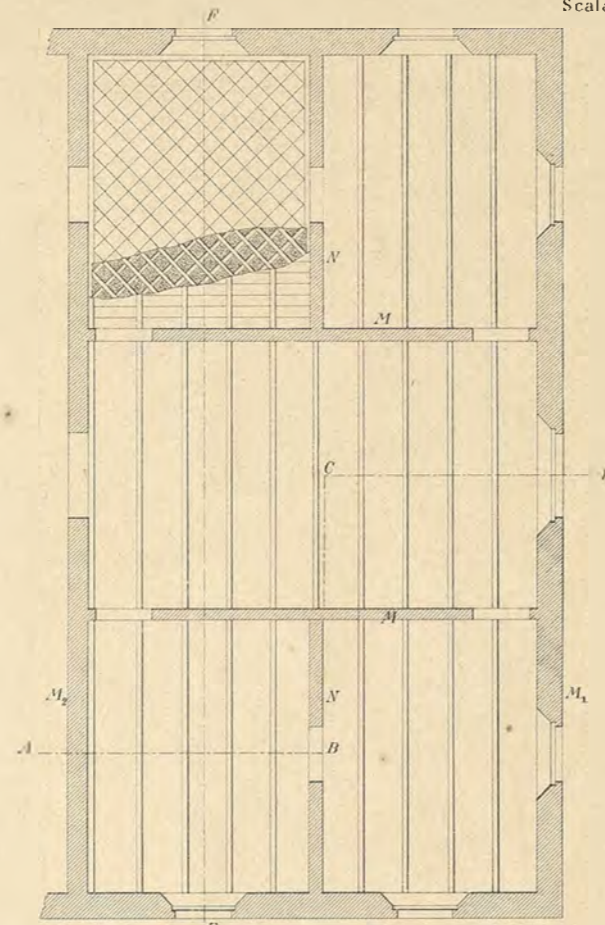


Fig. 86. Sezione secondo la ABCD

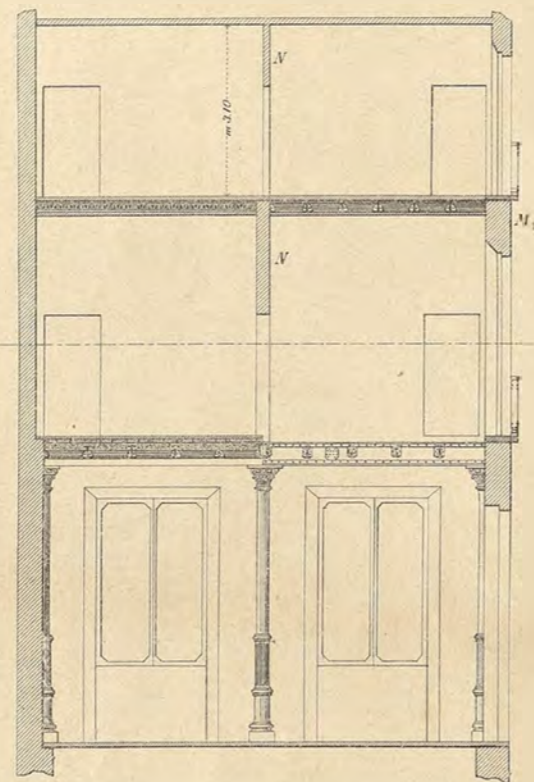


Fig. 87 - Pianta del Piano Terra

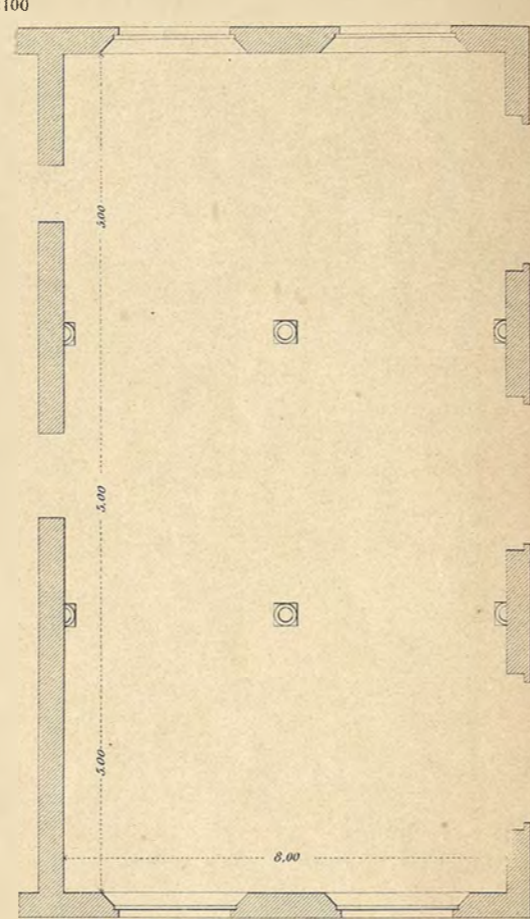


Fig. 89. Sezione secondo la EF

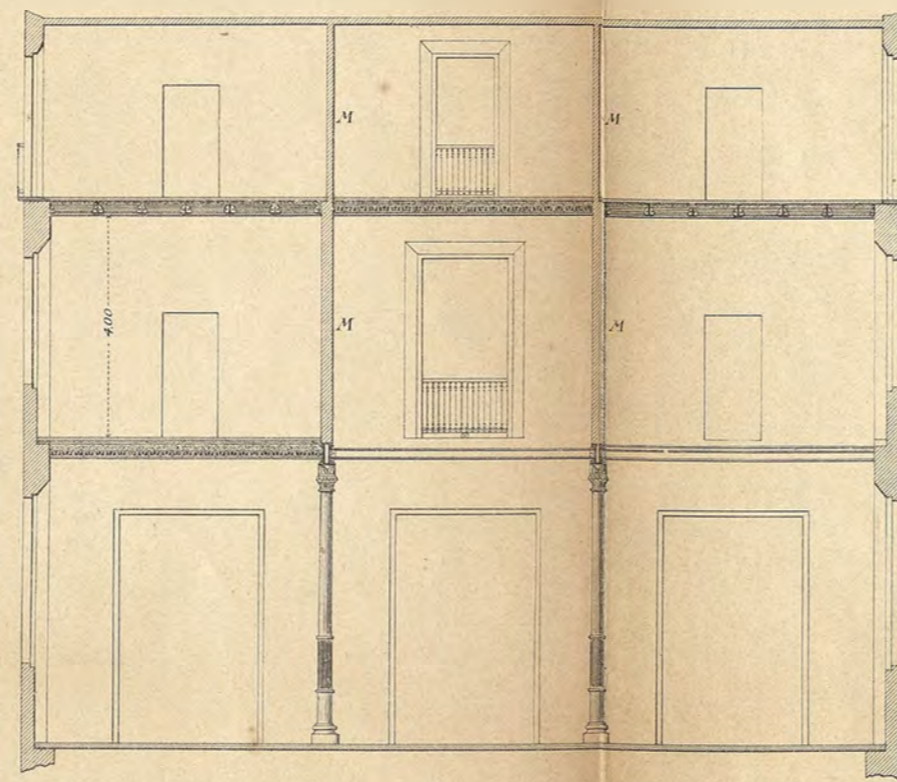


Fig. 90 - Trave composta sostenente i muri trasversali
Scala 1:25

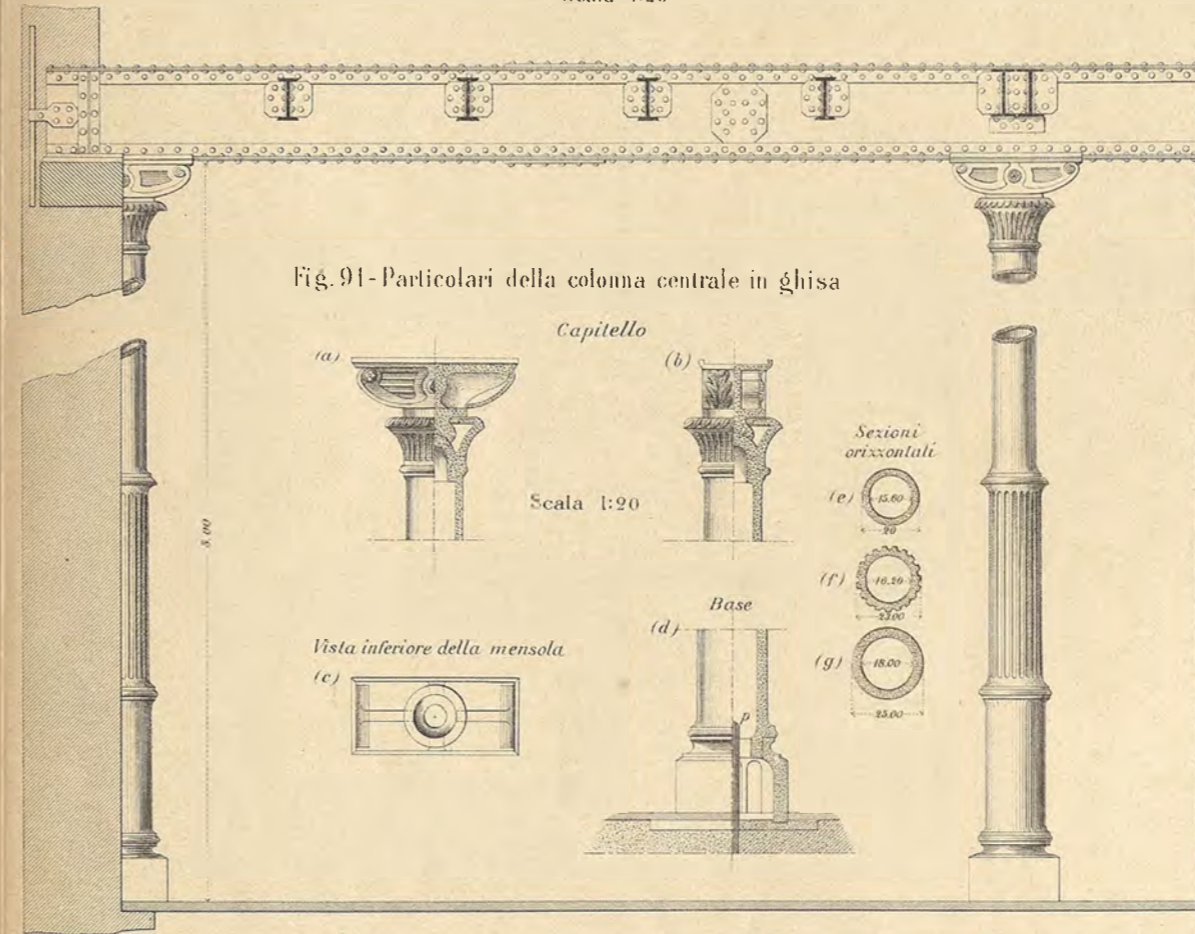


Fig. 91 - Particolari della colonna centrale in ghisa

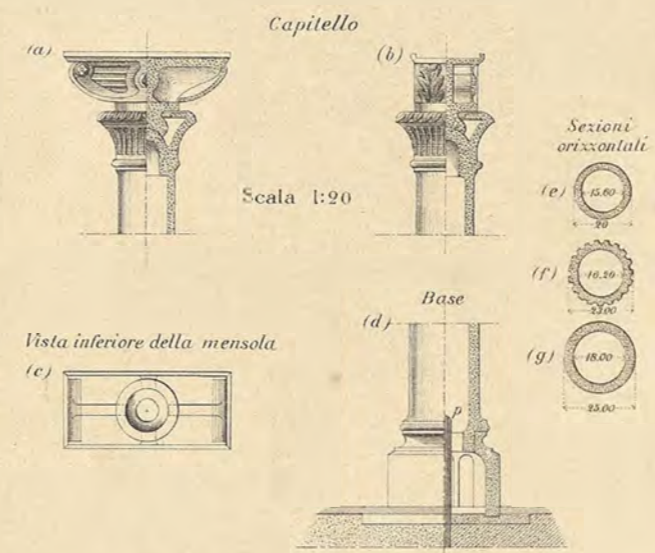


Fig. 92 - Appoggio della trave
Scala 1:10

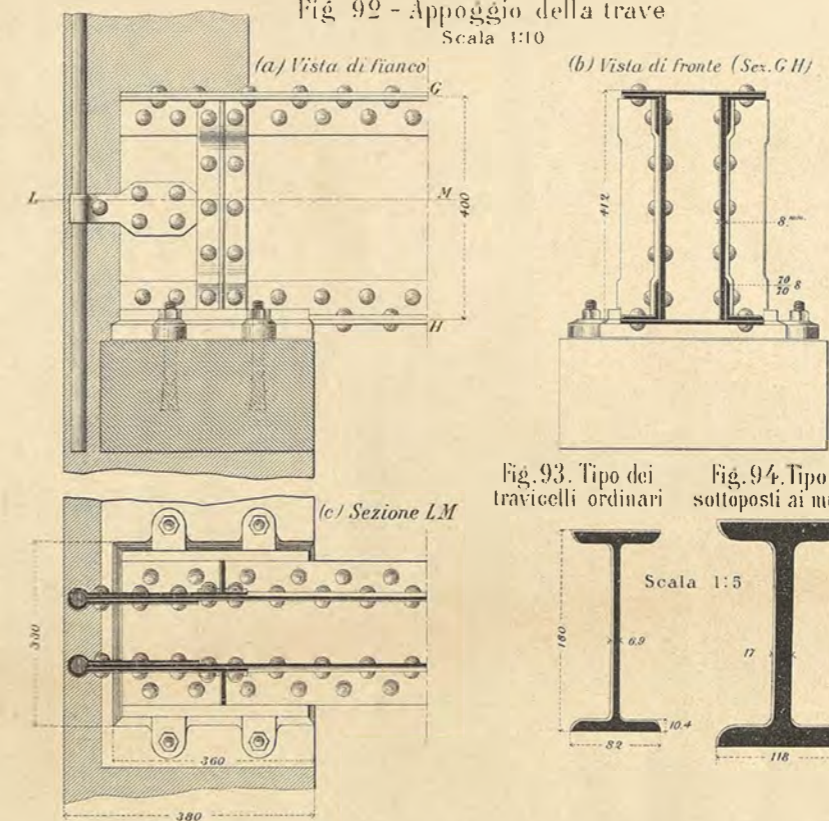
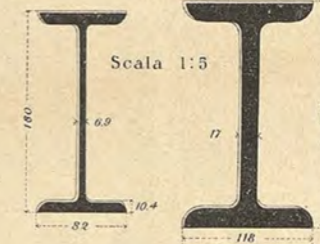


Fig. 93. Tipo dei tralicelli ordinari

Fig. 94. Tipo dei tralicelli sottoposti ai muri di tramezzo



STUDI DI SOLAI IN FERRO

Raccolta di progetti di costruzioni in legno ed in metallo.

Tavola VII

Particolari delle volterrane e del pavimento

Fig. 95 - Vista

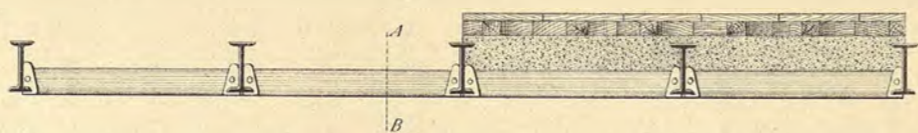


Fig. 96 - Pianta

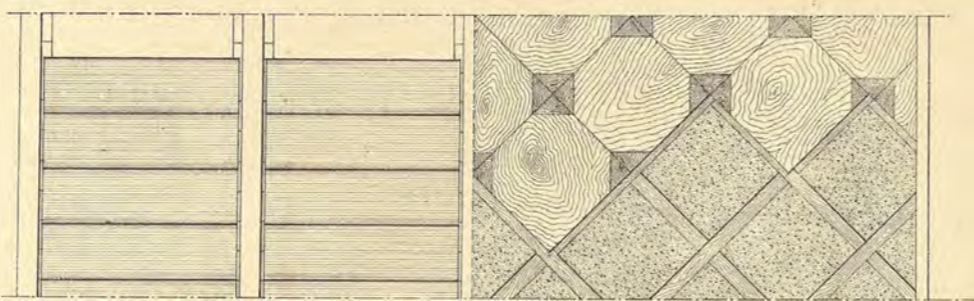


Fig. 97 - Sezione AB



Attacco dei travicelli ordinari alla trave maestra (Scala 1:20)

Fig. 98 - Sezione AB

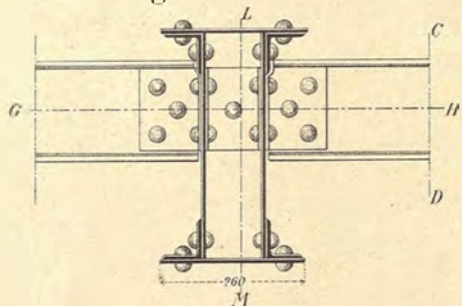


Fig. 99 - Sezione CD

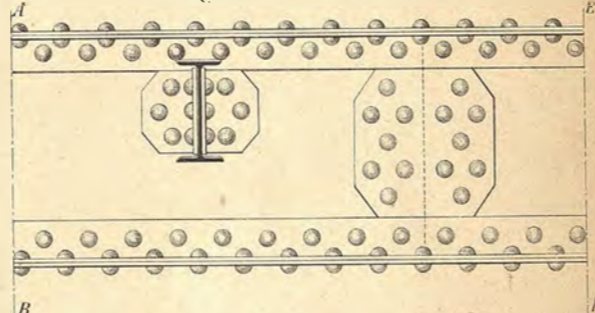


Fig. 101 - Sezione GH

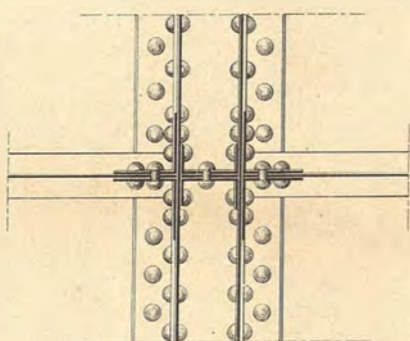
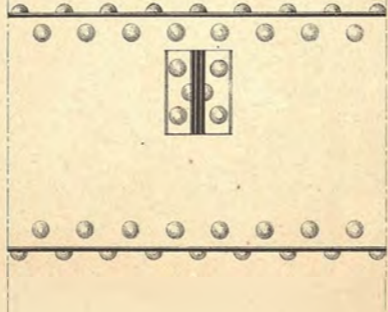


Fig. 102 - Sezione LM



Particolari d'attacco dei travicelli accoppiati alla trave maestra

Fig. 103 - Sezione CD

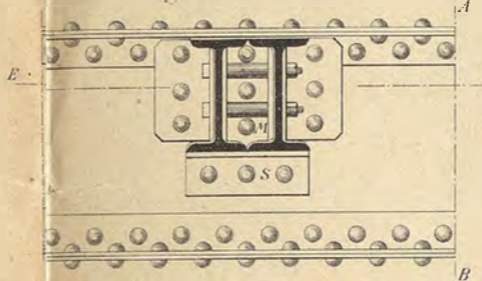


Fig. 104 - Sezione AB

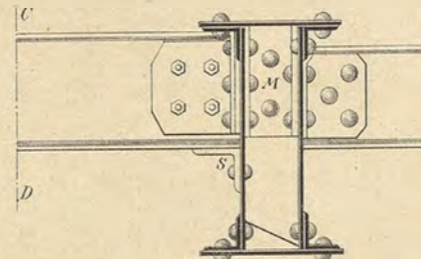


Fig. 106 - Particolare dell'attacco interno della trave

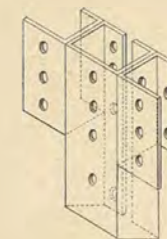
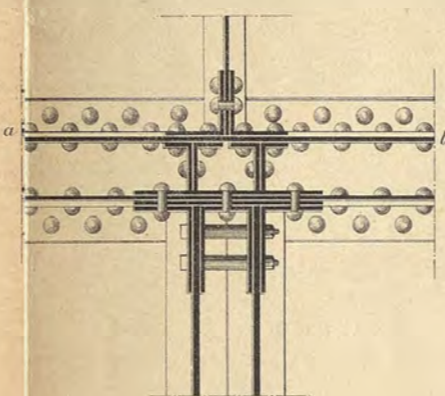


Fig. 105 - Sezione EF



Appoggio dei travicelli accoppiati

Fig. 107 - Vista

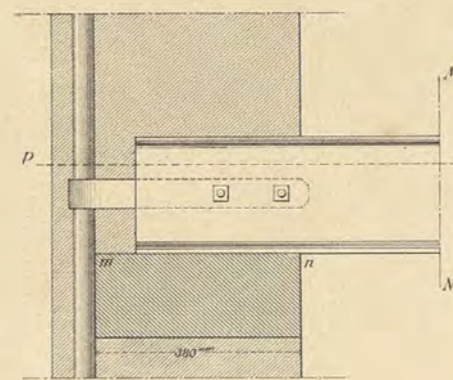


Fig. 108 - Sezione M N

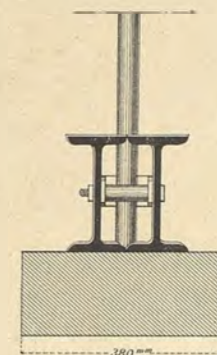


Fig. 109 - Sezione P Q

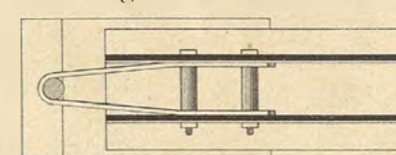


Fig. 110 - Particolare delle chiavard d'unione dei travicelli accoppiati

Scala 1:5

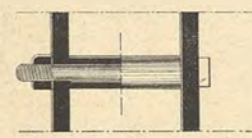


Fig. 111 - Diagramma per il calcolo dei travicelli di sostegno dei muri di tramezzo

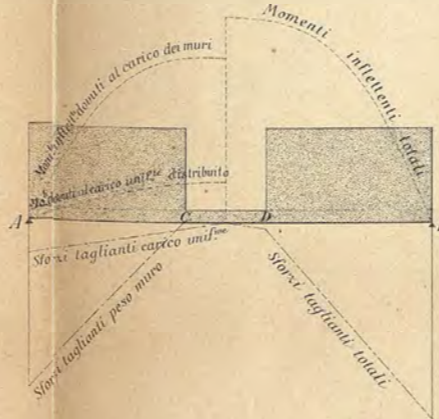
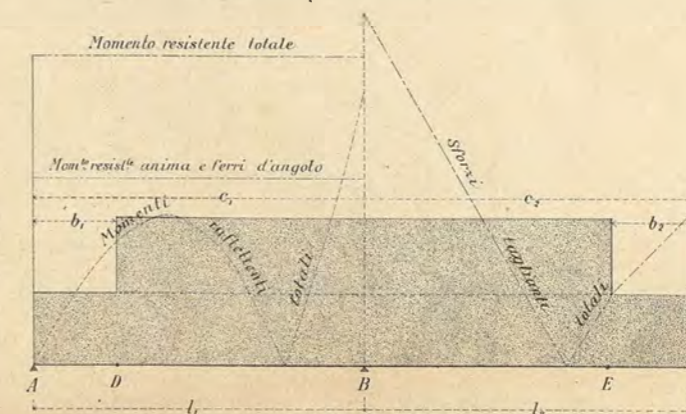


Fig. 112 - Diagramma per il calcolo delle travi maestre



SCALA { delle lunghezze 15^{mm} per metro
delle forze 1^{mm} per 200 Kg.
dei momenti 1^{mm} per 200 Kg_m.

